

COZ.	LARGURA	ALTURA	POTENC.	MATERIAL	TPO
PAV01	5,00	2,10	---	MOZUM - PAINEL EMBALE SINTÉTICO ACETINADO COM A DENTAR	ABRIL 1 FOLHA

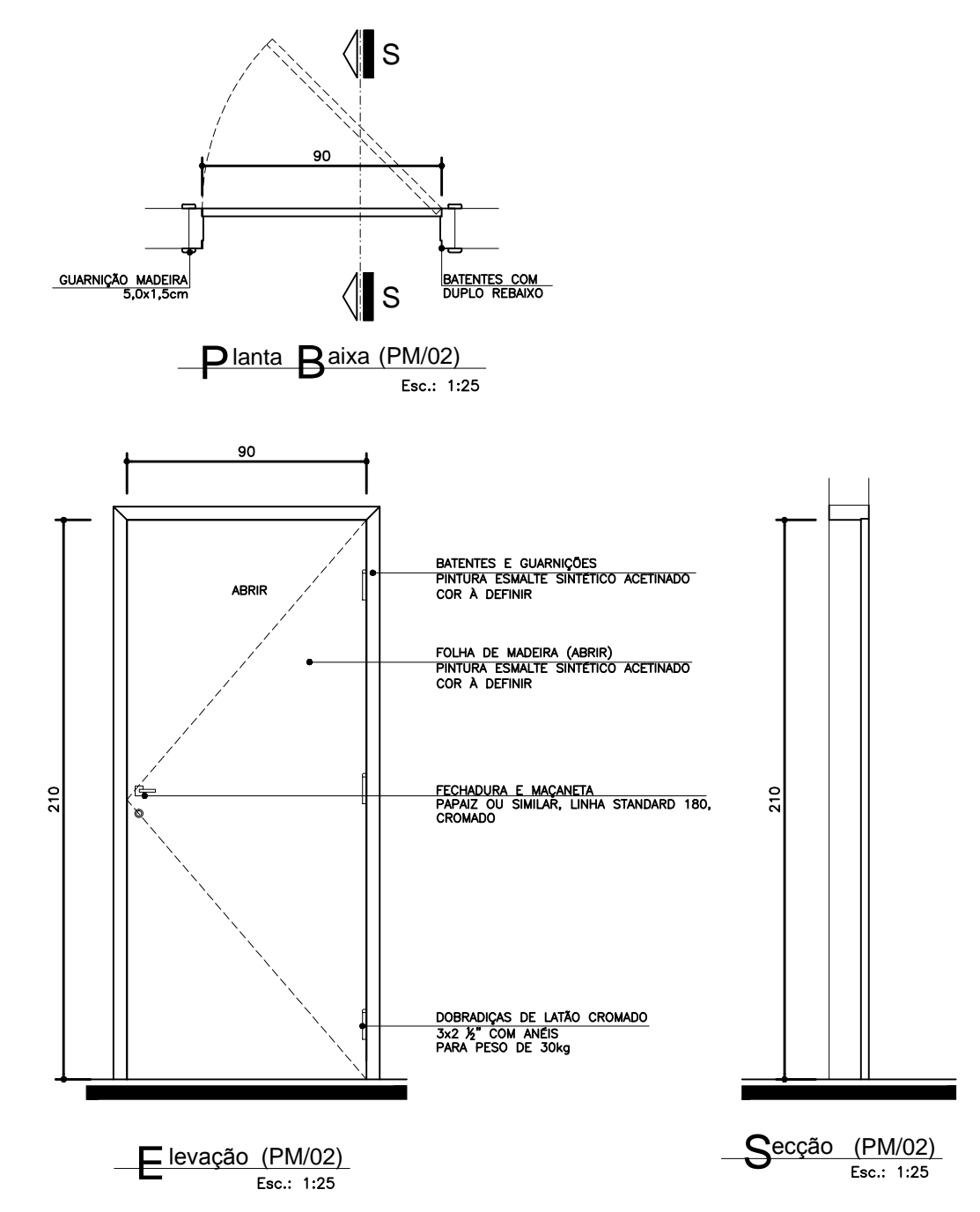

COZ.	LARGURA	ALTURA	POTENC.	MATERIAL	TPO
PAV02	5,00	2,10	---	MOZUM - PAINEL EMBALE SINTÉTICO ACETINADO COM A DENTAR	ABRIL 1 FOLHA

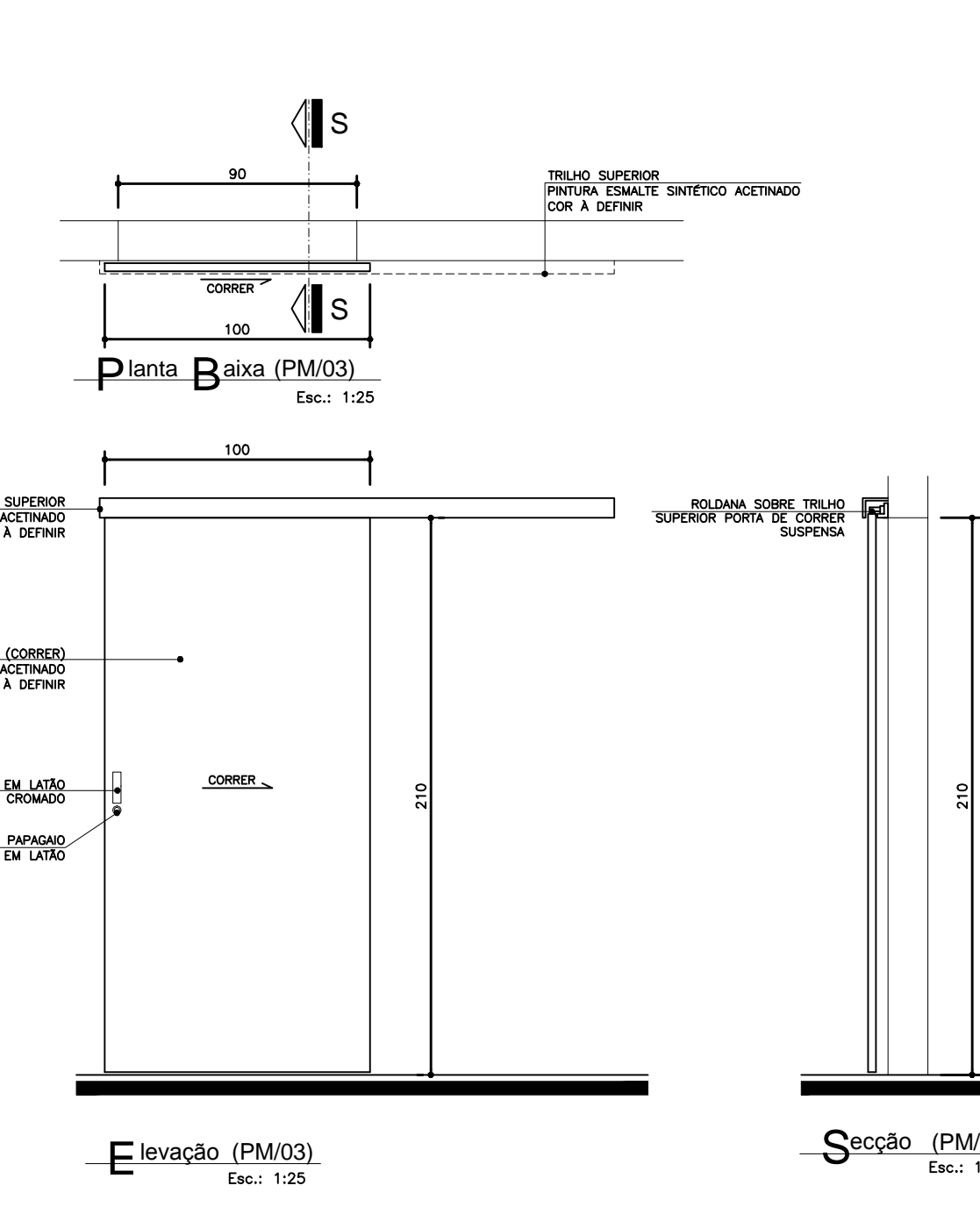

COZ.	LARGURA	ALTURA	POTENC.	MATERIAL	TPO
PAV03	5,00	2,10	---	MOZUM - PAINEL EMBALE SINTÉTICO ACETINADO COM A DENTAR	ABRIL 1 FOLHA

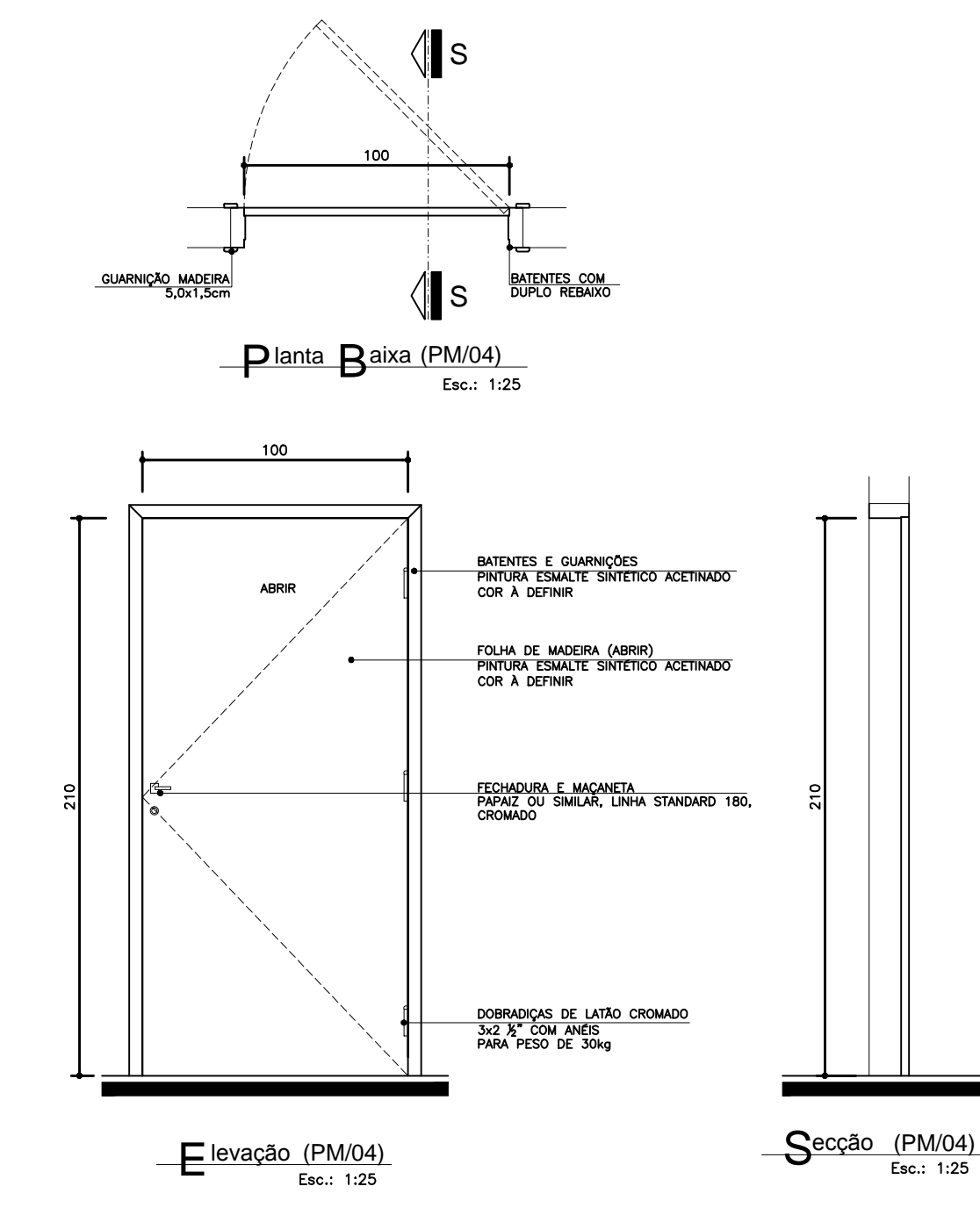

COZ.	LARGURA	ALTURA	POTENC.	MATERIAL	TPO
PAV04	5,00	2,10	---	MOZUM - PAINEL EMBALE SINTÉTICO ACETINADO COM A DENTAR	ABRIL 1 FOLHA

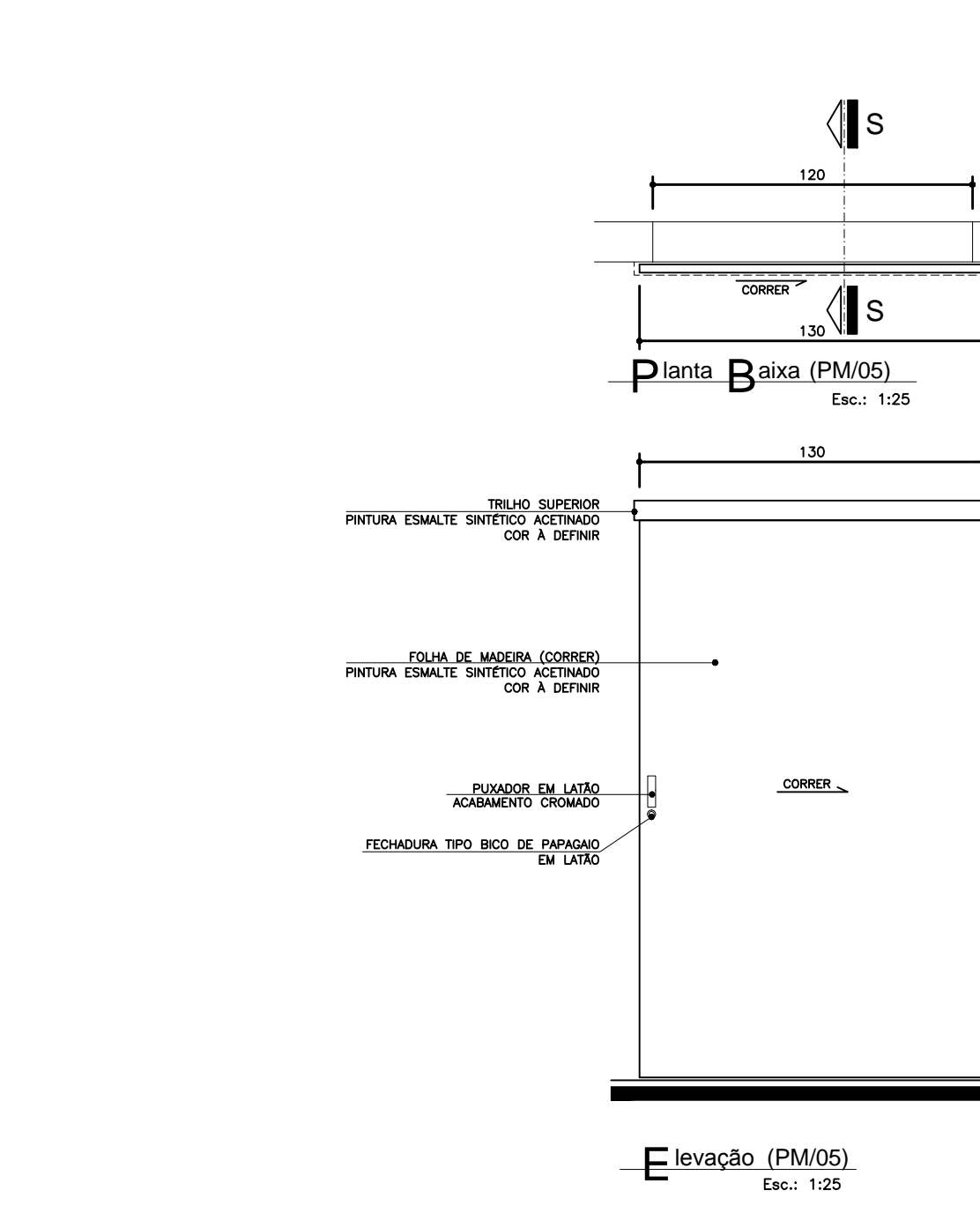

COZ.	LARGURA	ALTURA	POTENC.	MATERIAL	TPO
PAV05	5,00	2,10	---	MOZUM - PAINEL EMBALE SINTÉTICO ACETINADO COM A DENTAR	ABRIL 1 FOLHA

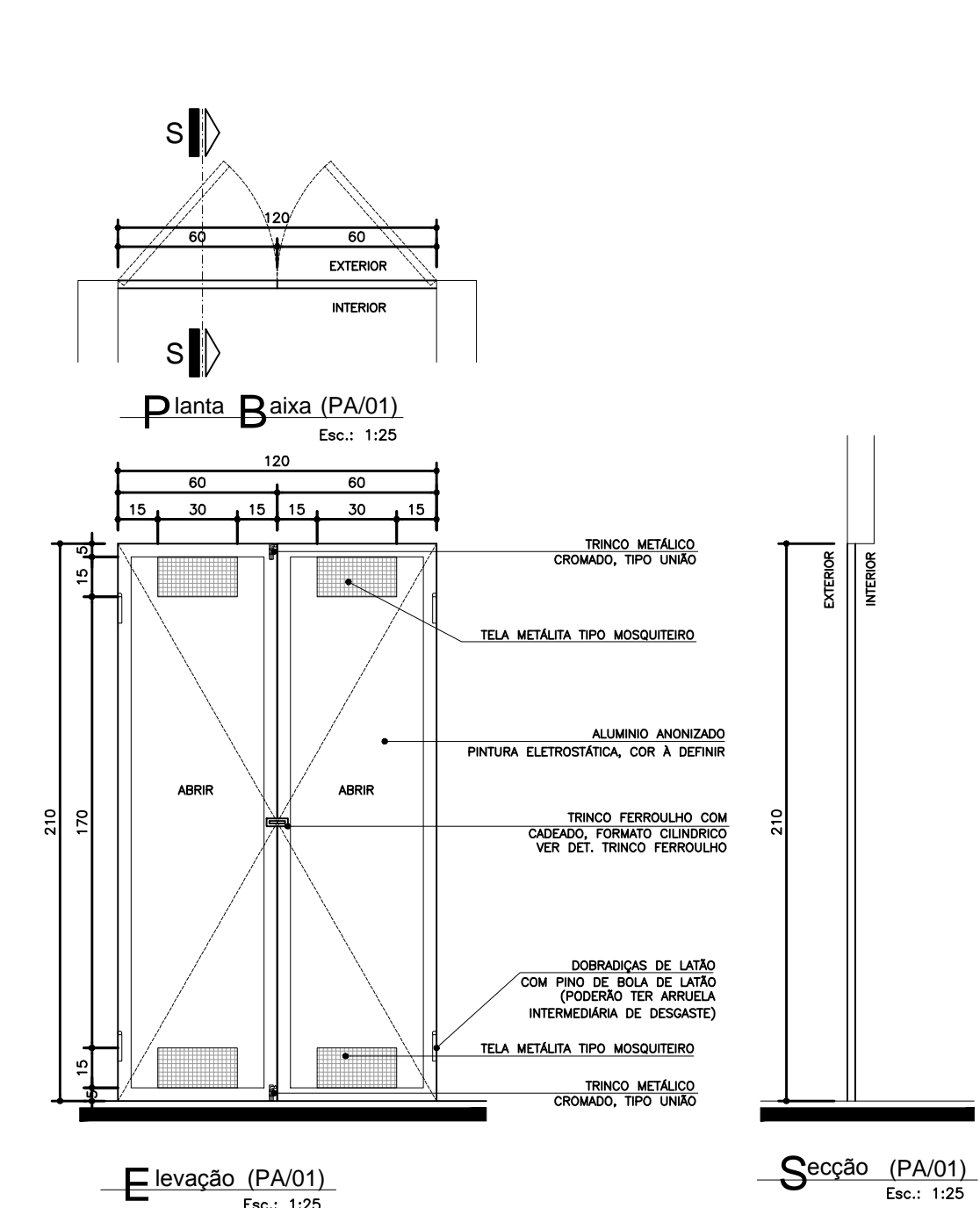

COZ.	LARGURA	ALTURA	POTENC.	MATERIAL	TPO
PAV01	1,00	0,40	2,10	ALUMINIO ANODADO / TELA METALICA TPO MESH/STAINLESS	ABRIL 3 FOLHAS

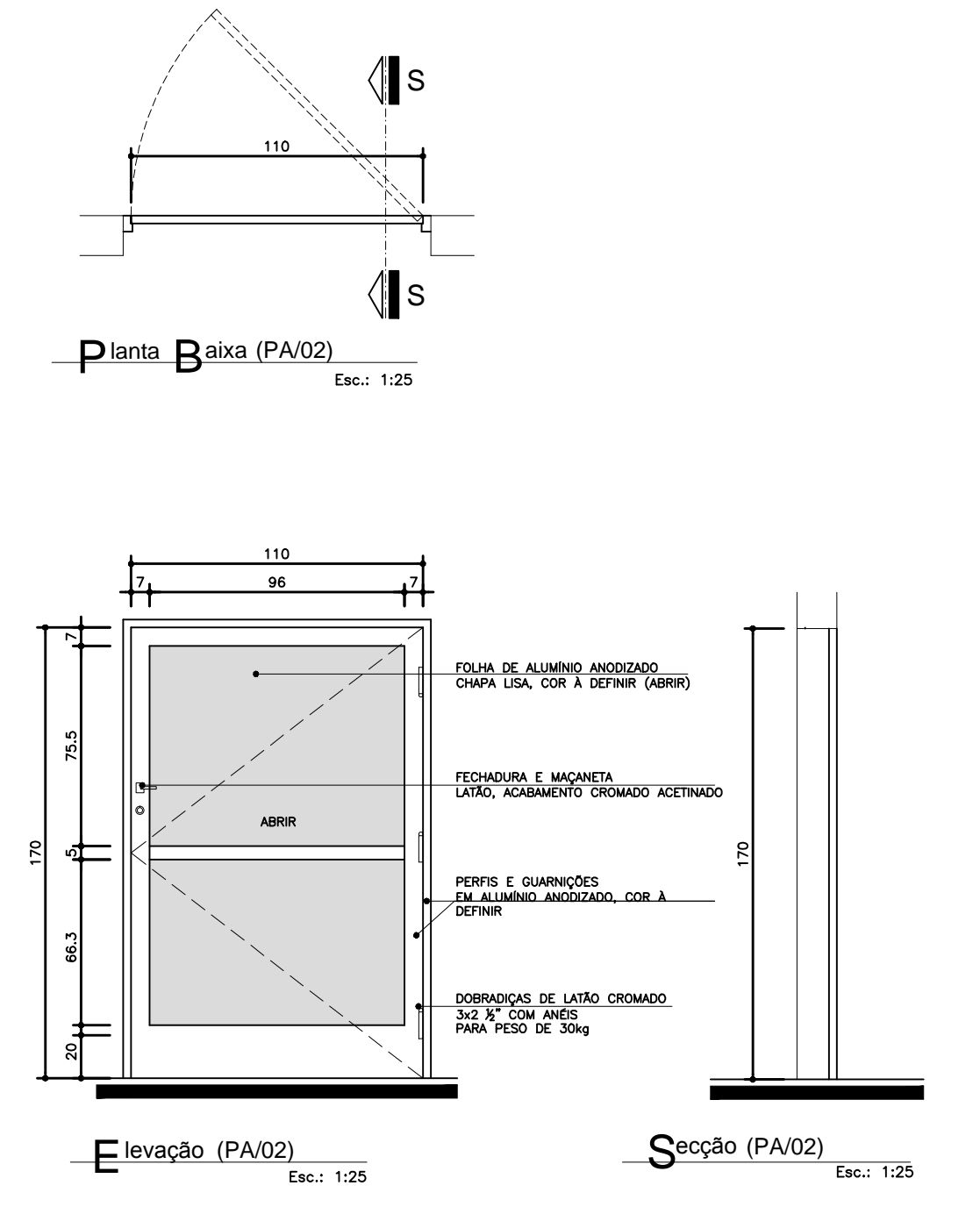

COZ.	LARGURA	ALTURA	POTENC.	MATERIAL	TPO
PAV02	1,10	1,10	---	ALUMINIO ANODADO COM A DENTAR	ABRIL 1 FOLHA

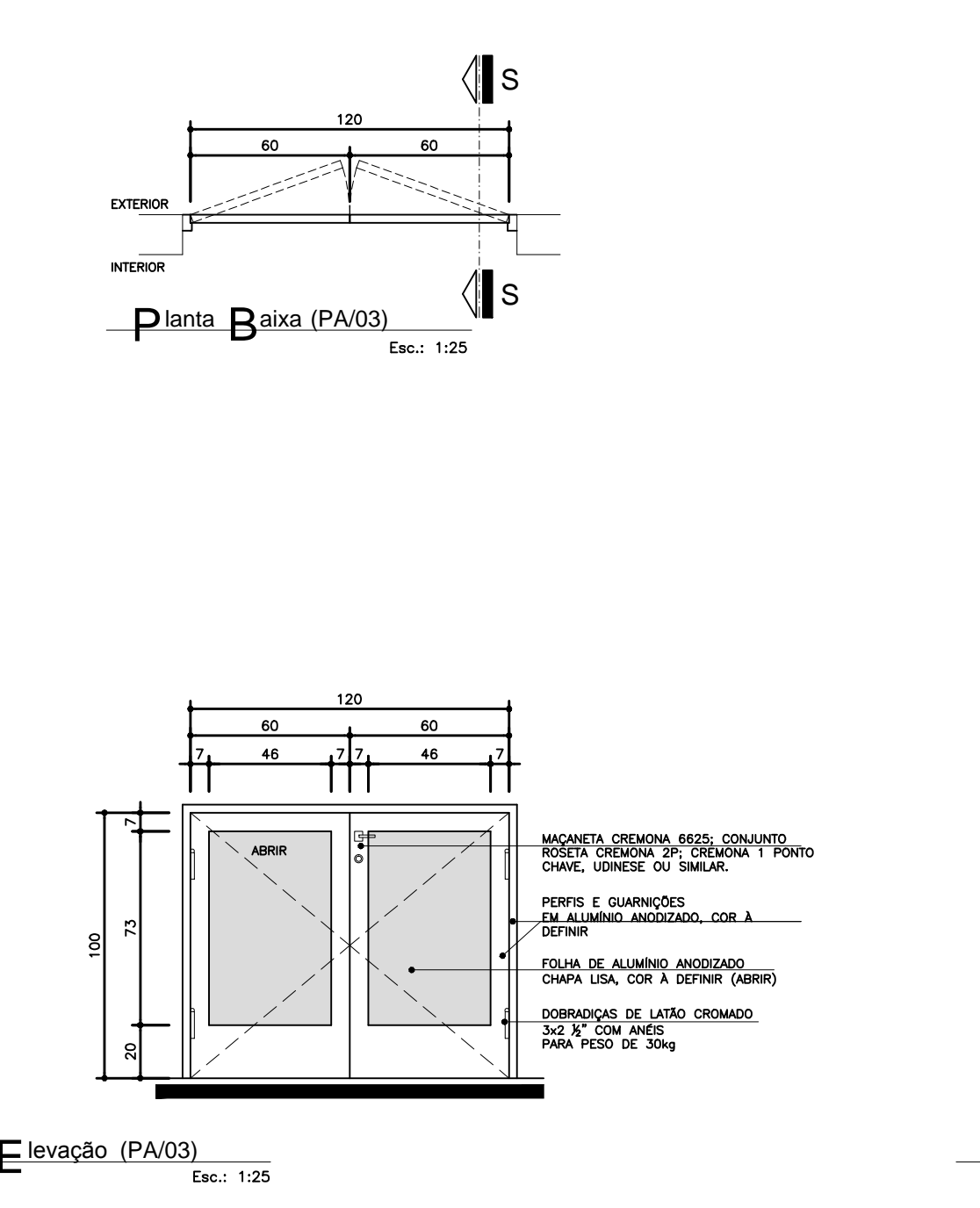

COZ.	LARGURA	ALTURA	POTENC.	MATERIAL	TPO
PAV03	1,20	0,40	1,40	ALUMINIO ANODADO COM A DENTAR	ABRIL 1 FOLHA

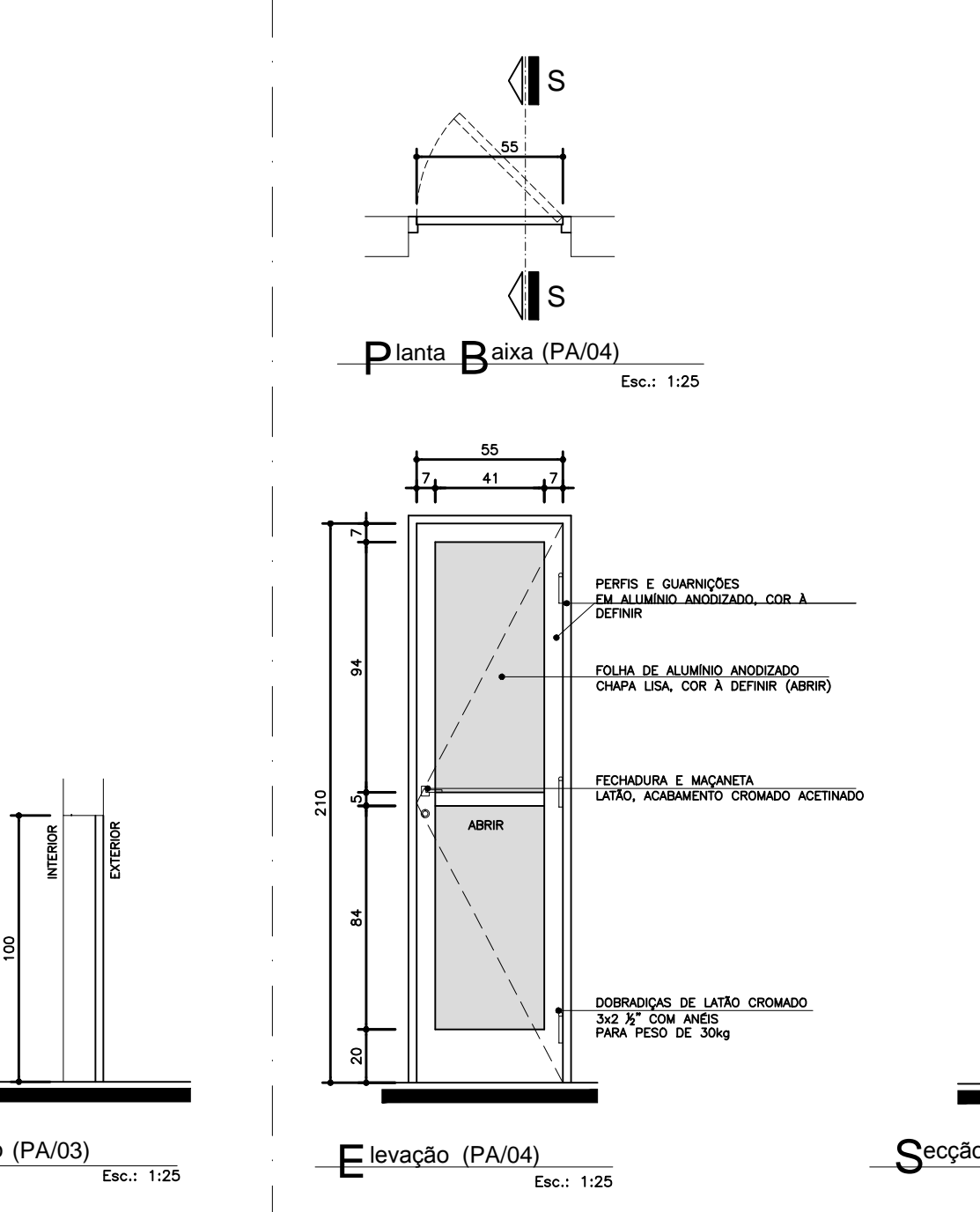

COZ.	LARGURA	ALTURA	POTENC.	MATERIAL	TPO
PAV04	0,55	2,10	---	ALUMINIO ANODADO COM A DENTAR	ABRIL 1 FOLHA

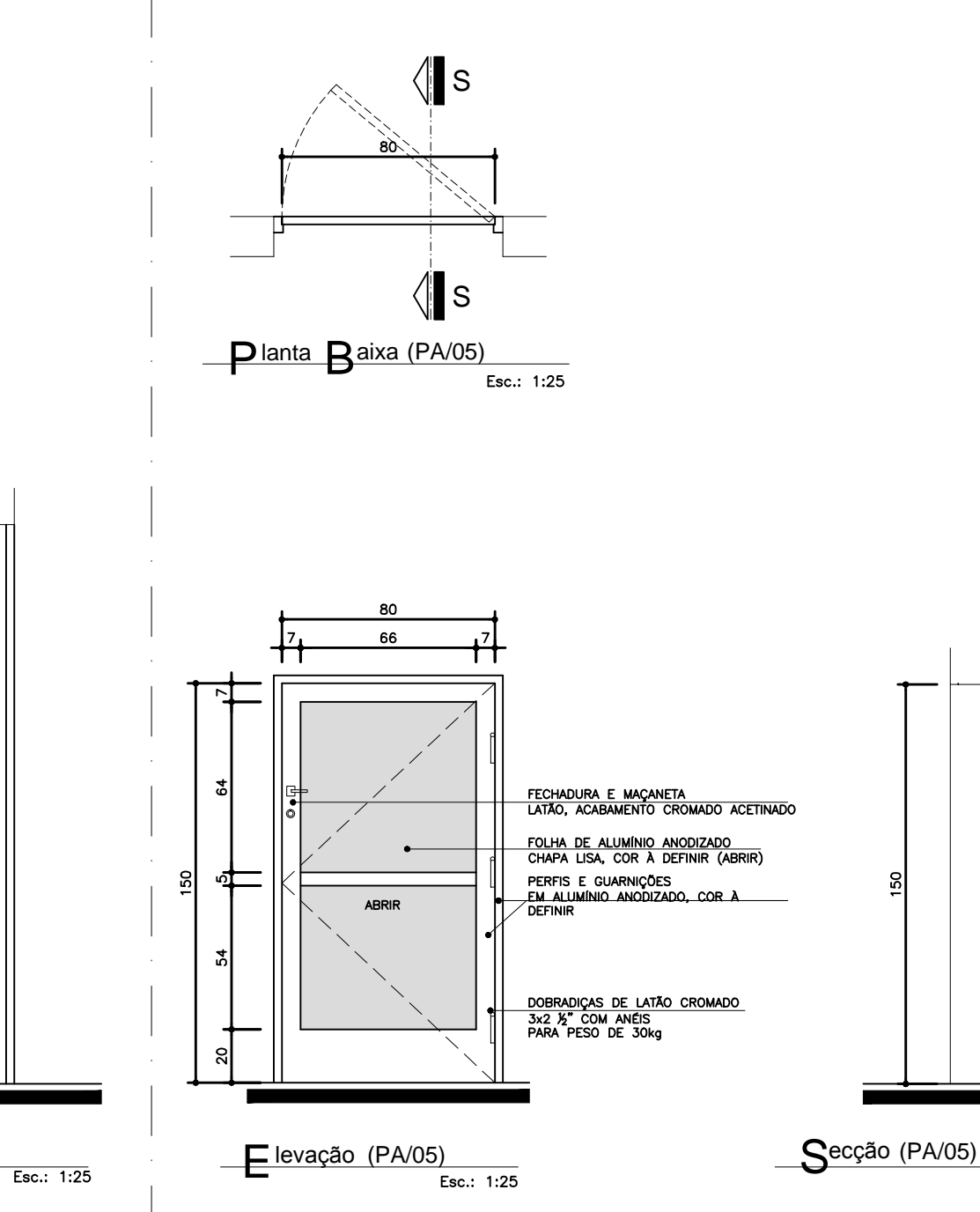

COZ.	LARGURA	ALTURA	POTENC.	MATERIAL	TPO
PAV05	0,80	1,10	---	ALUMINIO ANODADO COM A DENTAR	ABRIL 1 FOLHA

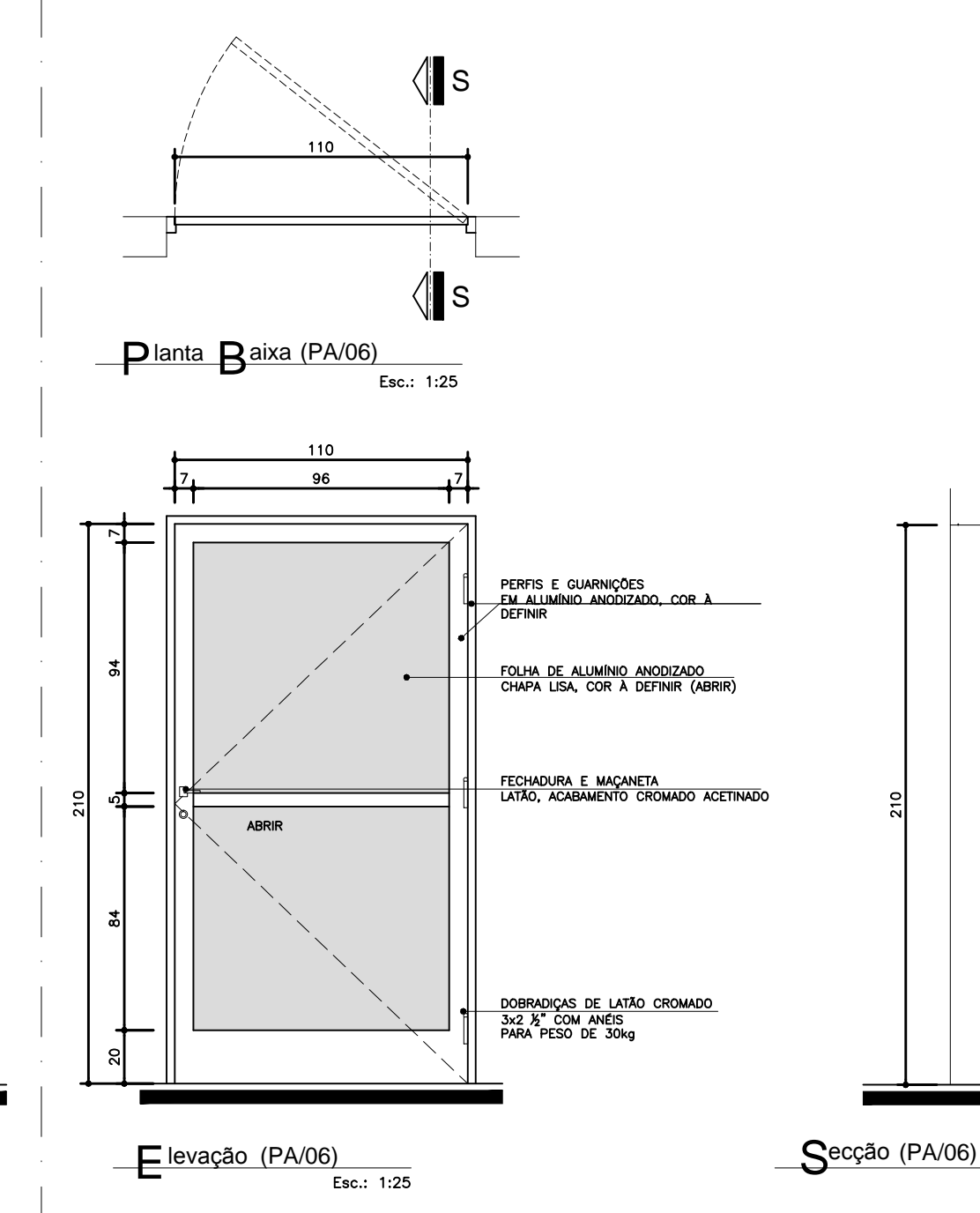

COZ.	LARGURA	ALTURA	POTENC.	MATERIAL	TPO
PAV06	1,10	2,10	---	ALUMINIO ANODADO COM A DENTAR	ABRIL 1 FOLHA

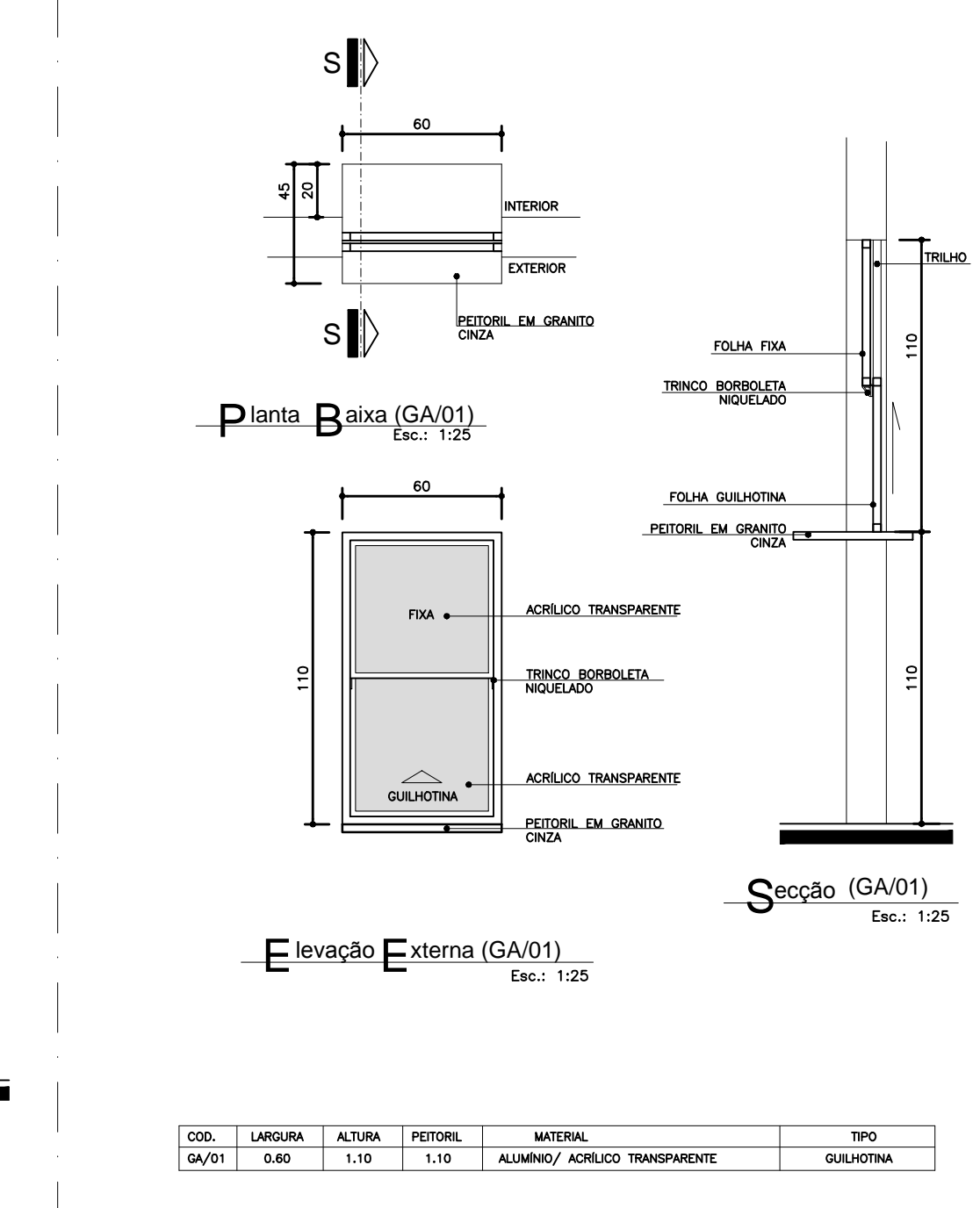

COZ.	LARGURA	ALTURA	POTENC.	MATERIAL	TPO
PAV07	0,60	1,10	1,10	ALUMINIO ANODADO TRANSPARENTE	ABRIL/MAI

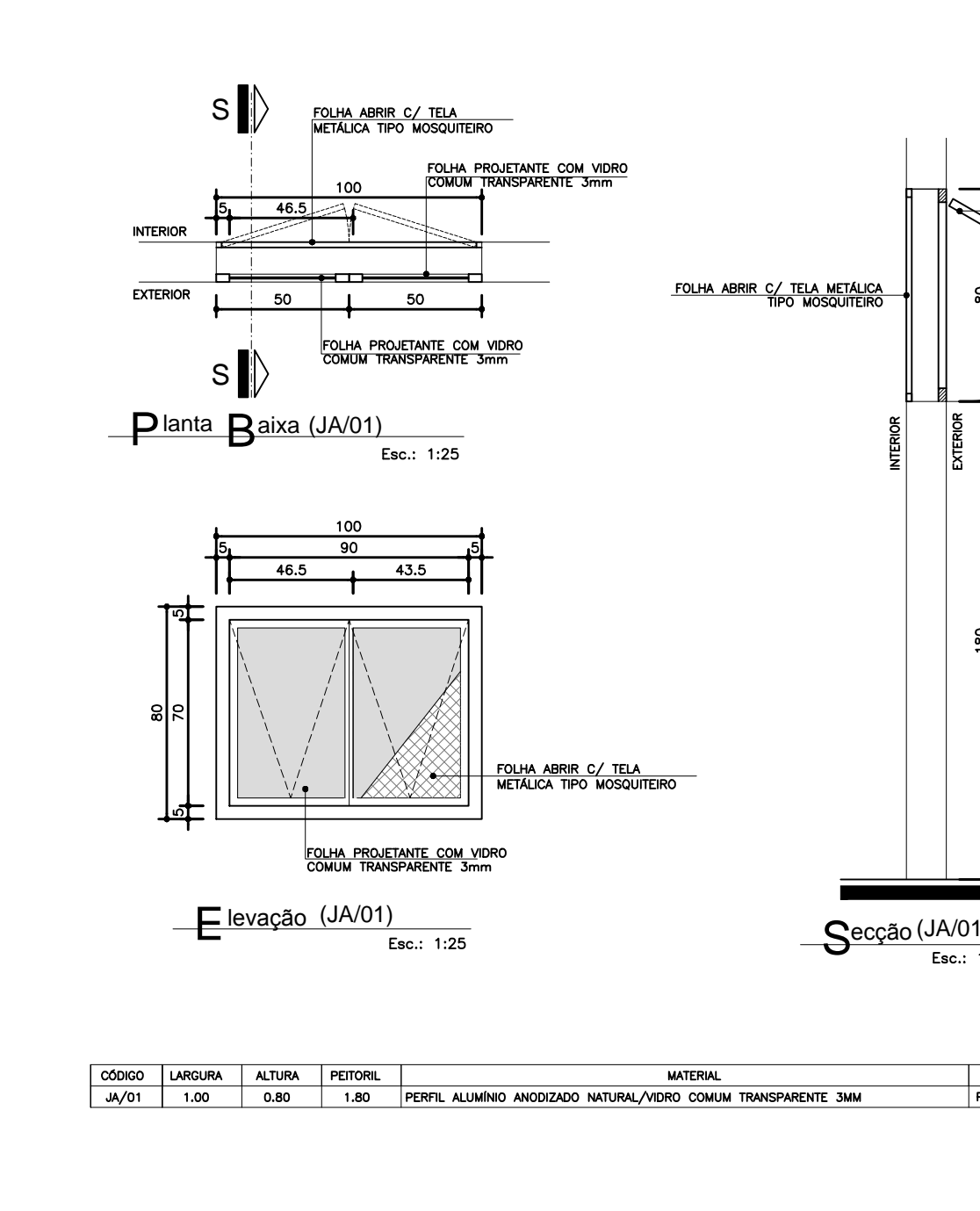

COZ.	LARGURA	ALTURA	POTENC.	MATERIAL	TPO
PAV08	1,10	0,80	1,40	PERFIL ALUMINIO ANODADO METALICO/COZUM TRANSPARENTE 30x3	PRELIMINAR 1 FOLHA

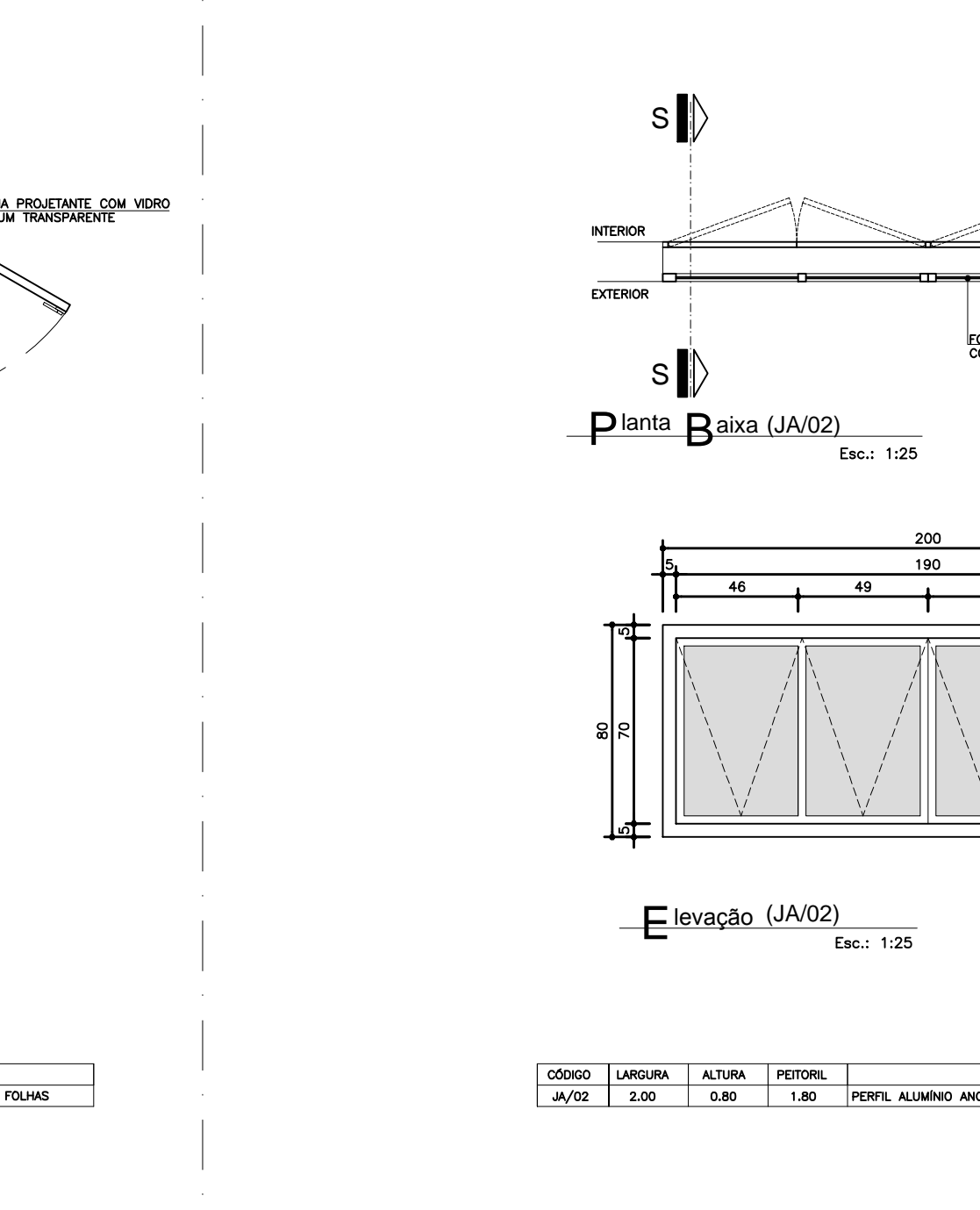

COZ.	LARGURA	ALTURA	POTENC.	MATERIAL	TPO
PAV09	0,80	0,80	1,40	PERFIL ALUMINIO ANODADO METALICO/COZUM TRANSPARENTE 30x3	PRELIMINAR 1 FOLHA

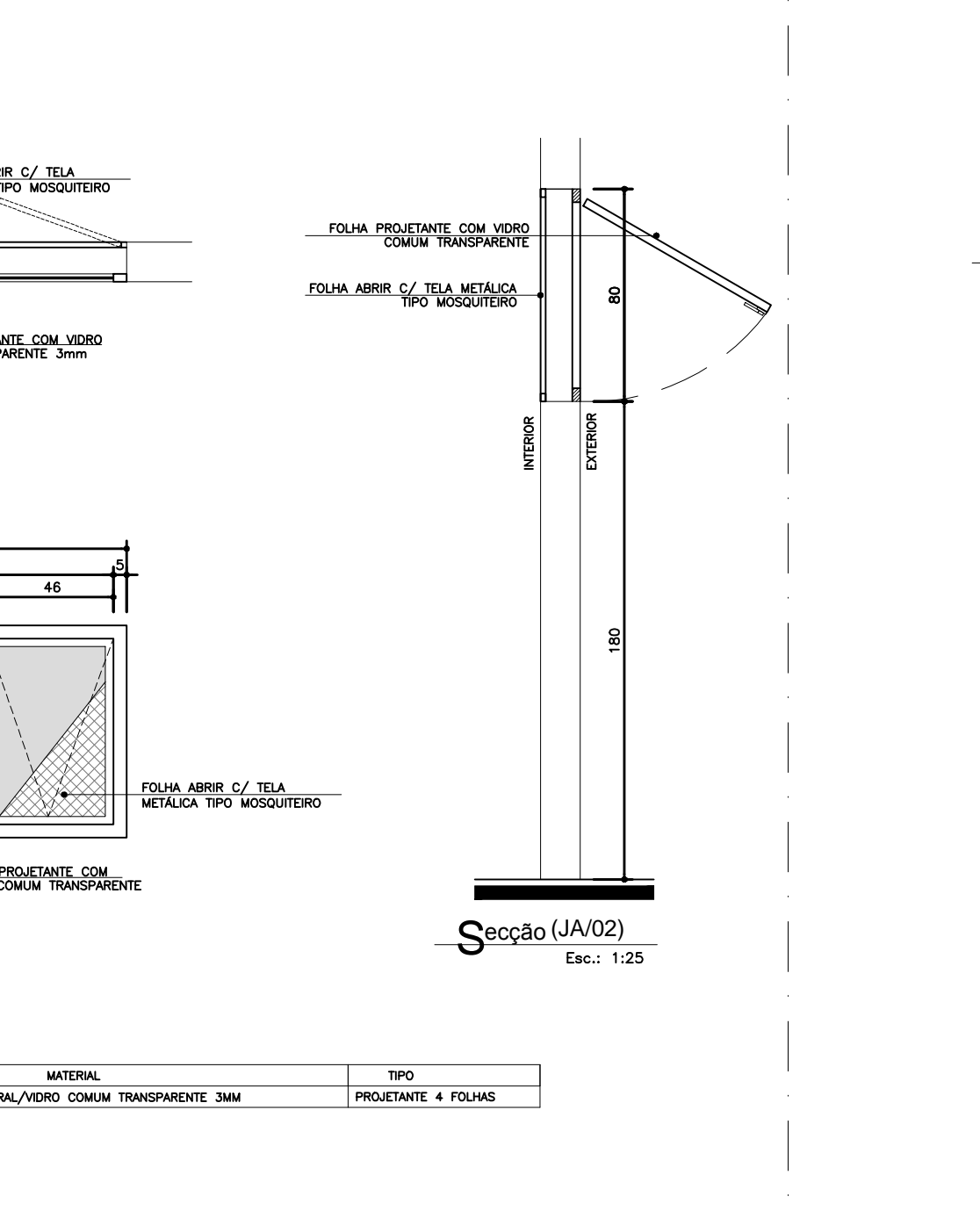

COZ.	LARGURA	ALTURA	POTENC.	MATERIAL	TPO
PAV10	2,00	2,20	2,40	PERFIL ALUMINIO ANODADO METALICO/COZUM TRANSPARENTE 30x3	PRELIMINAR 4 FOLHAS / FOLHA BANCADA

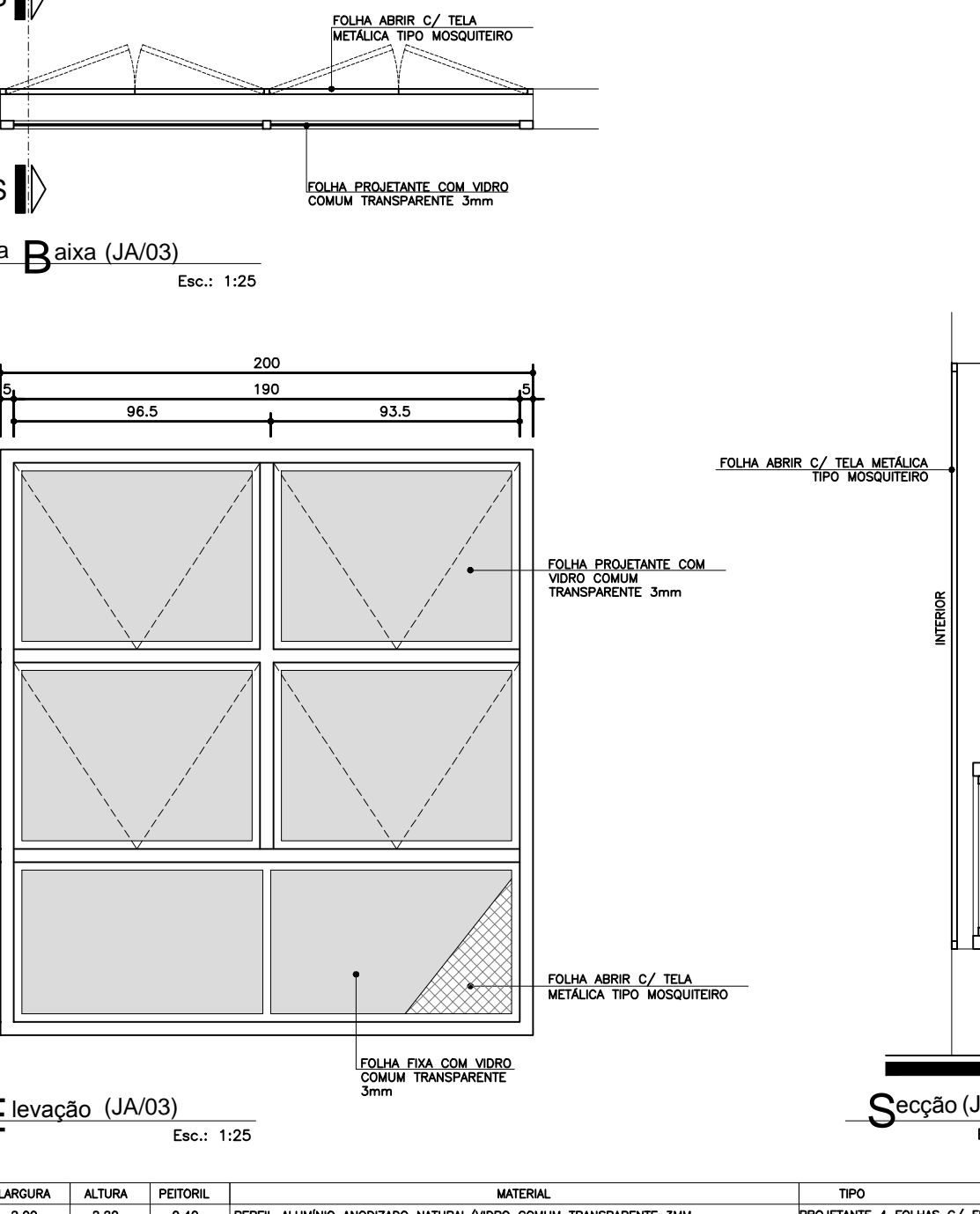

COZ.	LARGURA	ALTURA	POTENC.	MATERIAL	TPO
PAV11	1,80	1,40	1,40	PERFIL ALUMINIO ANODADO METALICO/COZUM TRANSPARENTE 30x3	PRELIMINAR 1 FOLHA

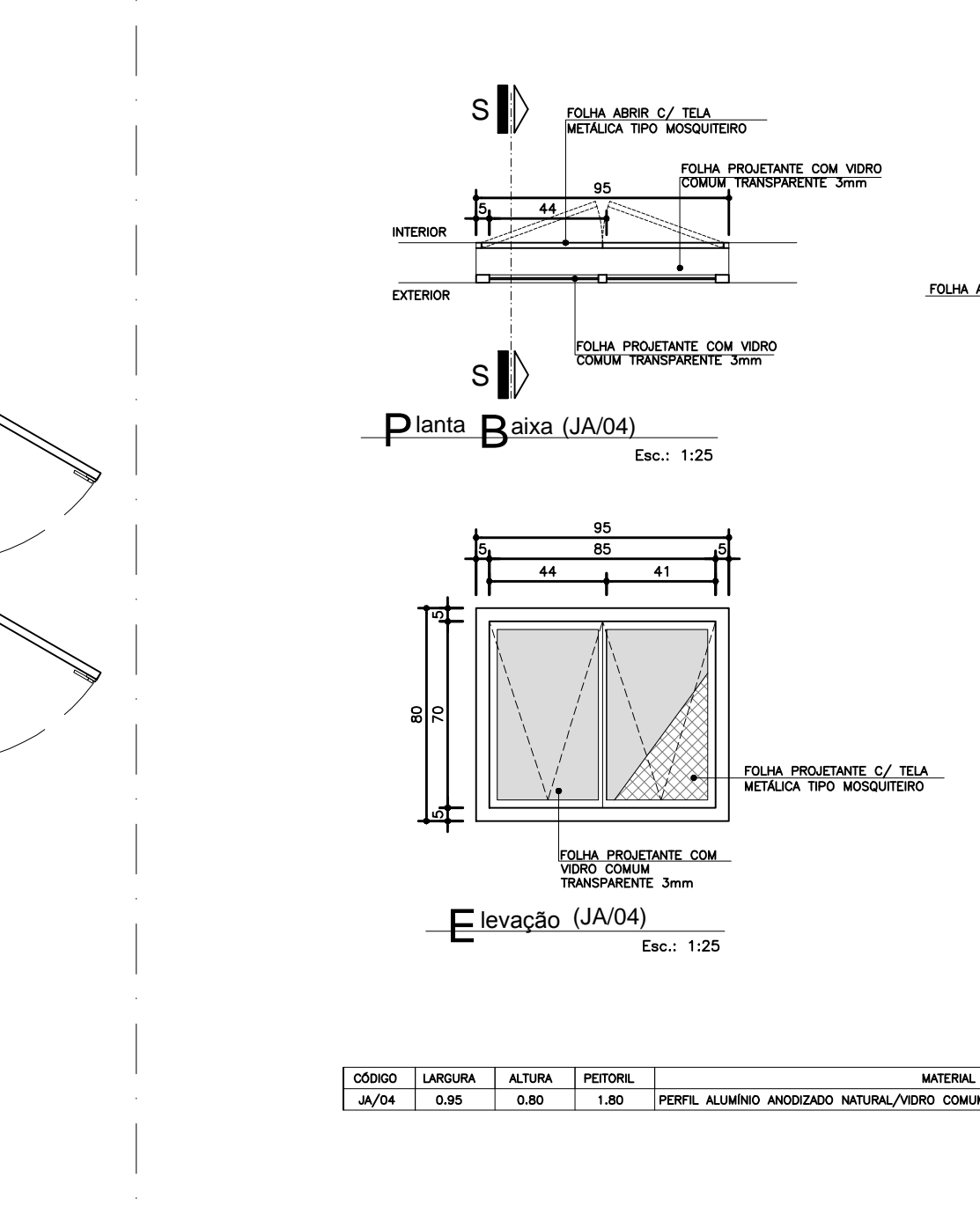

COZ.	LARGURA	ALTURA	POTENC.	MATERIAL	TPO
PAV12	1,00	0,40	1,40	PERFIL ALUMINIO ANODADO METALICO/COZUM TRANSPARENTE 30x3	PRELIMINAR 1 FOLHA

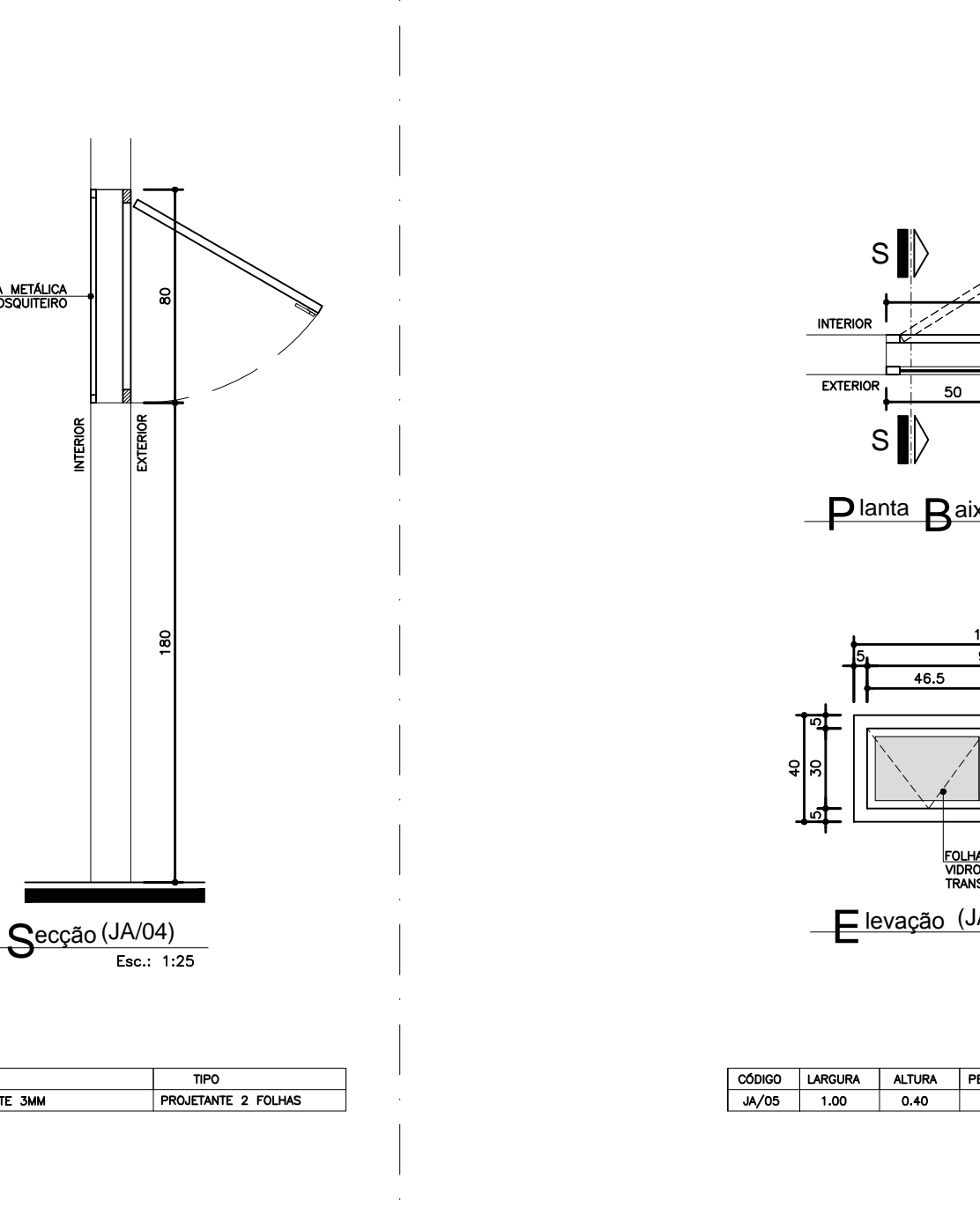

COZ.	LARGURA	ALTURA	POTENC.	MATERIAL	TPO
PAV13	1,00	0,40	1,40	PERFIL ALUMINIO ANODADO METALICO/COZUM TRANSPARENTE 30x3	PRELIMINAR 1 FOLHA

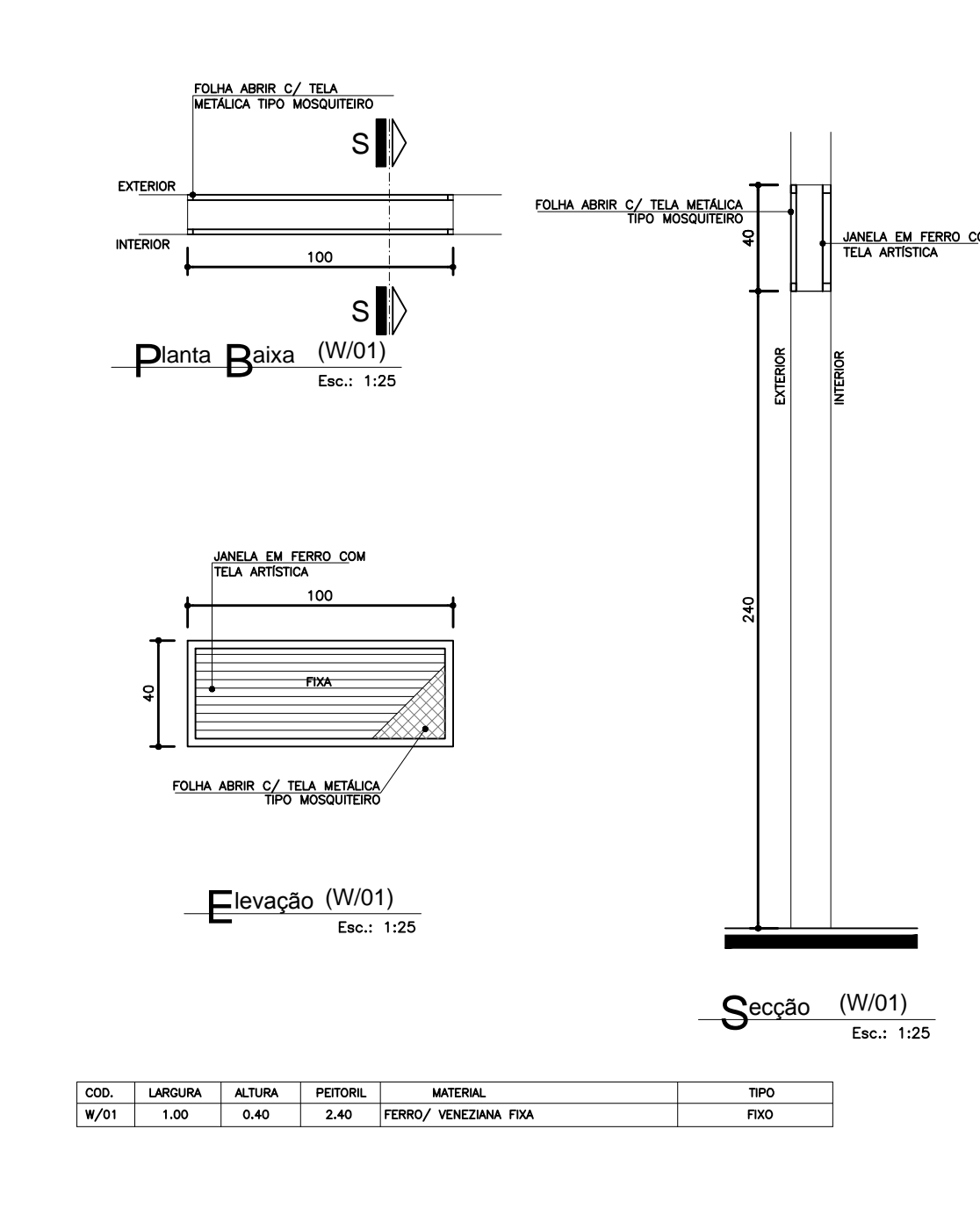

COZ.	LARGURA	ALTURA	POTENC.	MATERIAL	TPO
PAV14	1,00	0,40	1,40	PERFIL ALUMINIO ANODADO	ABRIL 1 FOLHA

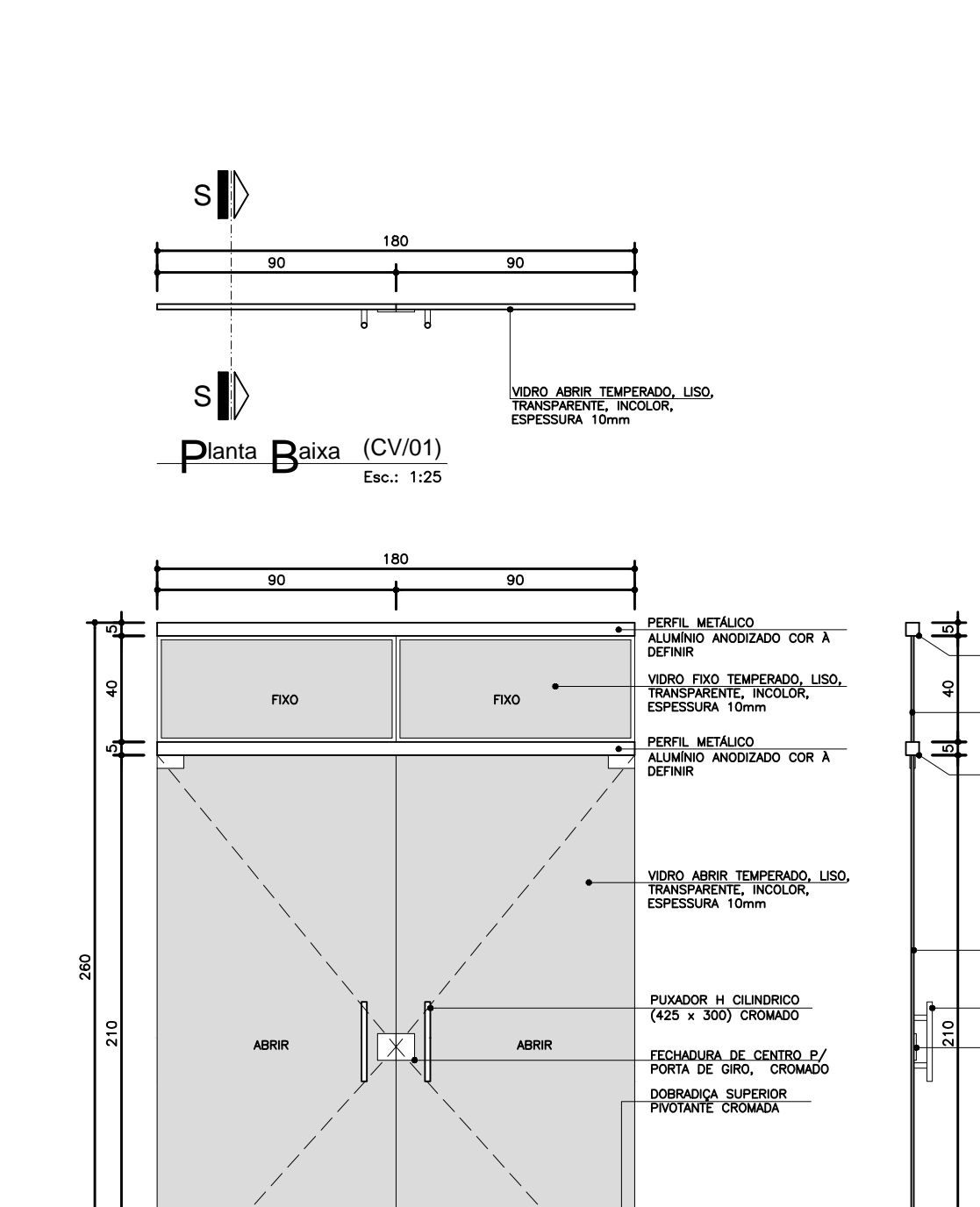

COZ.	LARGURA	ALTURA	POTENC.	MATERIAL	TPO
PAV15	1,40	2,40	---	PERFIL TRANSPARENTI POLICARBONATO 10x10	ABRIL 1 FOLHA

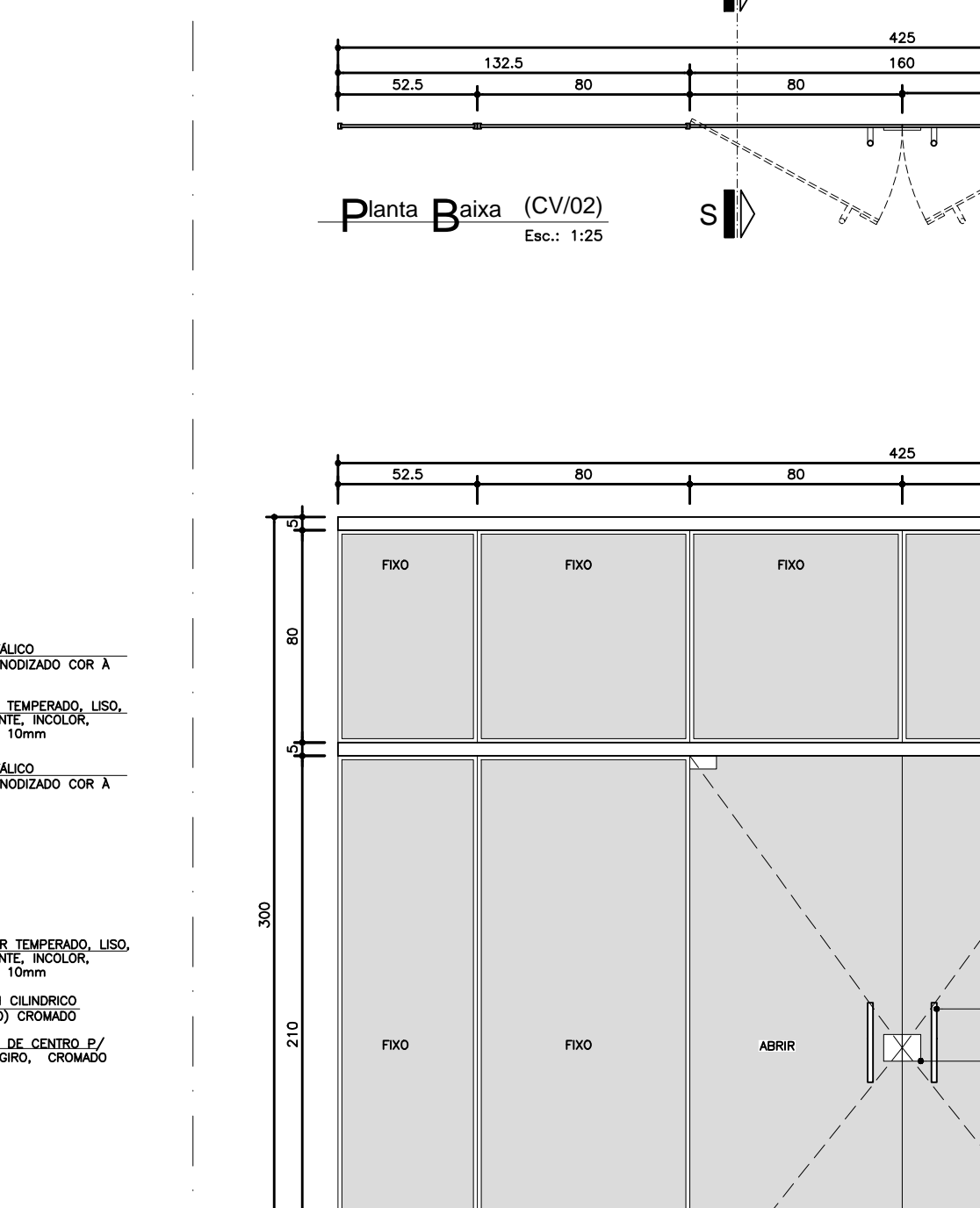

COZ.	LARGURA	ALTURA	POTENC.	MATERIAL	TPO
PAV16	4,00	0,80	---	PERFIL TRANSPARENTI POLICARBONATO 10x10	ABRIL 1 FOLHA / FOLHA

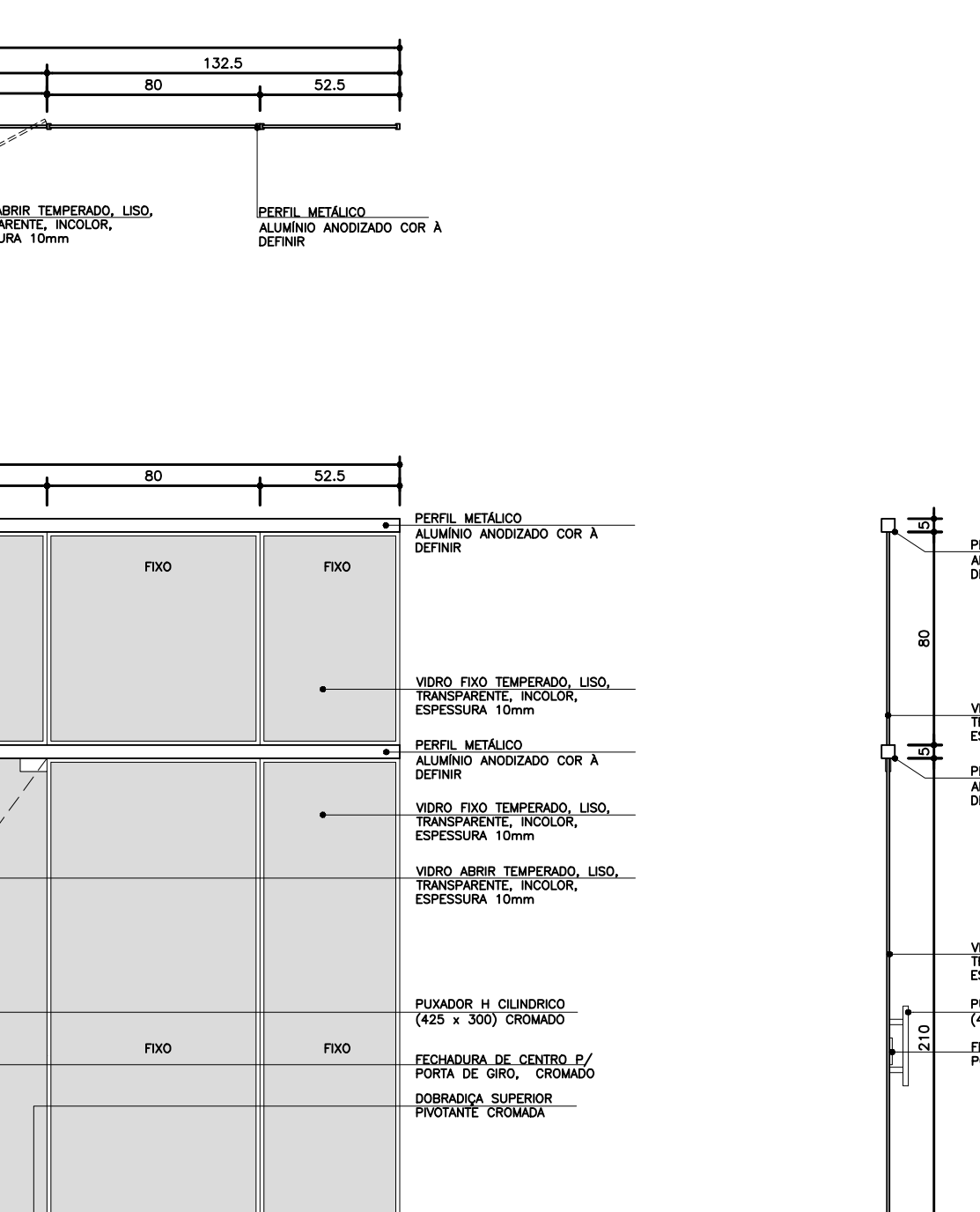

COZ.	LARGURA	ALTURA	POTENC.	MATERIAL	TPO
PAV17	1,40	2,40	---	ALUMINIO ANODADO COM A DENTAR	ABRIL 1 FOLHA

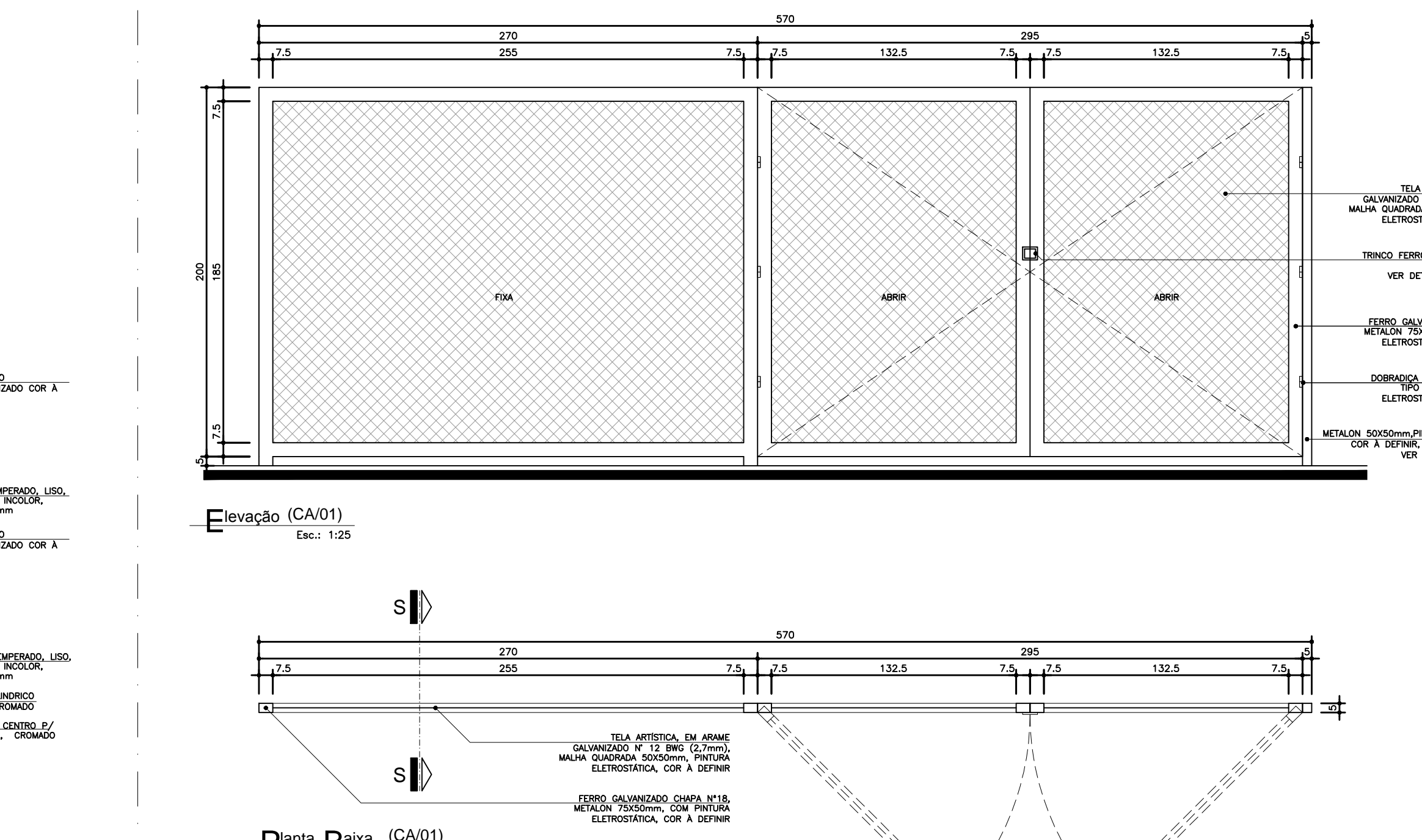

COZ.	LARGURA	ALTURA	POTENC.	MATERIAL	TPO
PAV18	1,40	2,40	---	ALUMINIO ANODADO COM A DENTAR	ABRIL 1 FOLHA

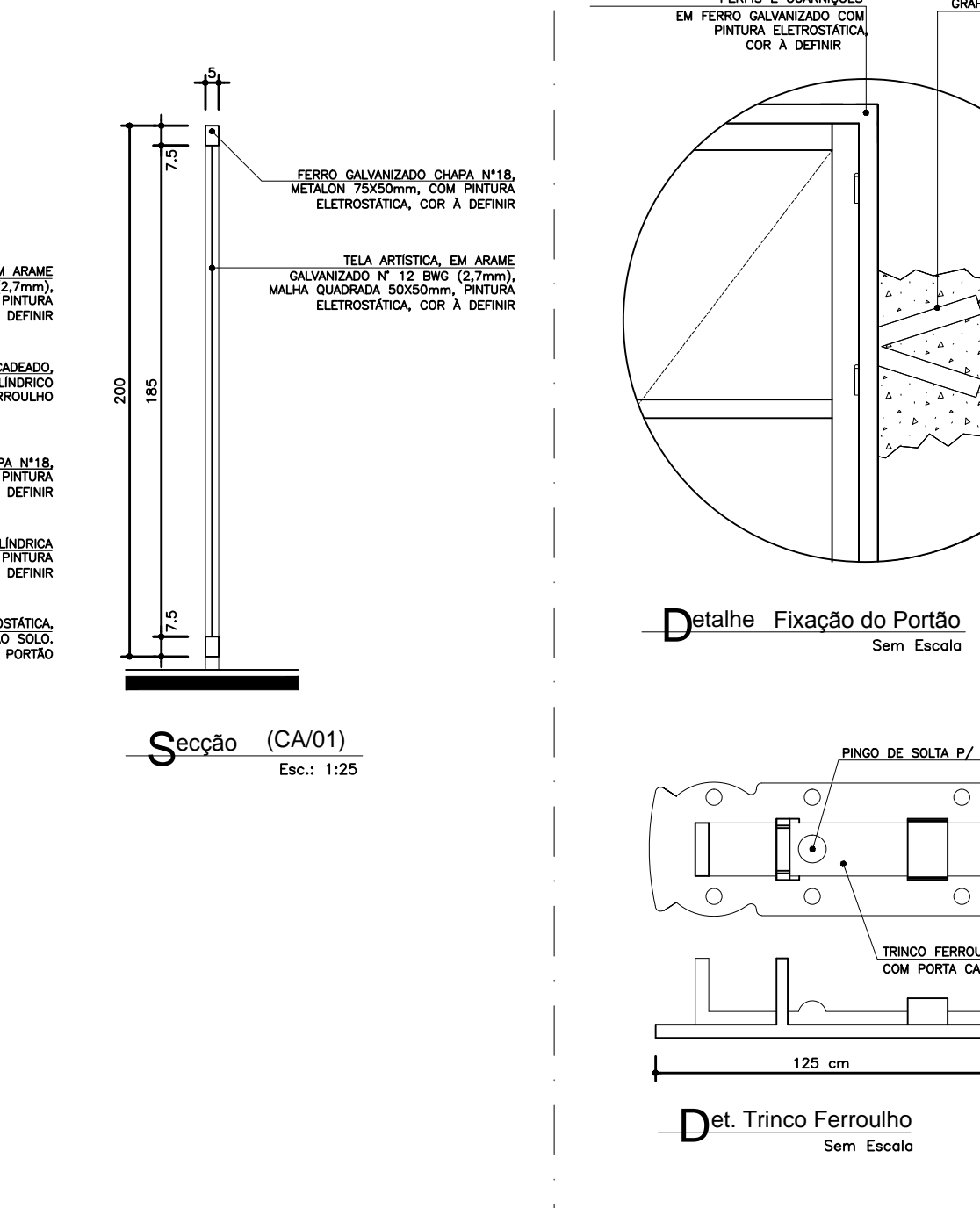

Observações:
 1) AS DIMENSÕES DEVEM SER LIDAS SEMPRE ENTRE AS LINHAS DE TELA.
 2) SE OCORREREM DÚVIDAS SOBRE AS MEDIDAS DOS BANCOS, DEVERÃO SER DO TIPO BANCOS, NÃO SEREM DO TIPO EXTERNA.

